

RESU

Installation Manual for RESU LV

RESU3.3 (R4863P3S)
RESU6.5 (R48126P3S)
RESU10 (R48189P3S)
RESU PLUS

LG Energy Solution strongly advises to take due care in following LG Energy Solution's product installation manual. A warranty claim is invalid if damage is caused by human error, inconsistent with the installation manual.

Version 2.8



Scan QR Code to view
[Installation Manual PDF File]



Scan QR code to view
[Installation Video Guide]



About this manual

This manual describes how to install LG Energy Solution's RESU® battery pack. Read this manual before you attempt to install the product, and follow the instructions throughout the installation process. If you are uncertain about any of the requirements, recommendations, or safety procedures described in this manual, contact LG Energy Solution immediately for advice and clarification.

The information included in this manual is accurate at the time of publication. However, the product specifications are subject to change without prior notice. In addition, the illustrations in this manual are meant to help explain system configuration concepts and installation instructions. The illustrated items may differ from the actual items at the installation location.

Contents

1 Safety

- 1.1 Symbols on product labels
- 1.2 Safety instructions
 - 1.2.1 General safety precautions
 - 1.2.2 Battery handling guide
- 1.3 Response to emergency situations
 - 1.3.1 Leaking batteries
 - 1.3.2 Fire
 - 1.3.3 Wet batteries
 - 1.3.4 Damaged batteries
- 1.4 Qualified installers
- 1.5 Contact information

2 Product Introduction

- 2.1 Technical data
 - 2.1.1 Dimensions and weight
 - 2.1.2 Performance
 - 2.1.3 Charging cable requirements
 - 2.1.4 Network cable requirements
 - 2.1.5 Environmental requirements
- 2.2 Features
- 2.3 **Maintenance**
- 2.4 RESU lineup
- 2.5 RESU Plus

3 Installation Prerequisites

- 3.1 Installation materials
- 3.2 Installation location
- 3.3 Tools
- 3.4 Safety gear
- 3.5 Making network cable

4 Battery Pack Installation

- 4.1 Unpacking
- 4.2 Package items
- 4.3 Optional accessories
- 4.4 Checks before installation
- 4.5 Installation clearance
- 4.6 Securing battery pack to wall
- 4.7 Cable connections
 - 4.7.1 Connecting ground wire
 - 4.7.2 Connecting network cable
 - 4.7.3 Connecting power cables for RESU Plus
 - 4.7.4 Connecting charging cables
- 4.8 Finalizing installation

5 RESU Plus Installation

- 5.1 Unpacking
- 5.2 Package items
- 5.3 Securing RESU Plus to wall
- 5.4 Cable connections
 - 5.4.1 Connecting charging cables
 - 5.4.2 Connecting ground wires
 - 5.4.3 Connecting power cables
 - 5.4.4 Connecting network cables
- 5.5 Finalizing installation

6 Configuration Switches

- 6.1 Configuring Battery pack
 - 6.1.1 Setting for communication interface
 - 6.1.2 Setting for battery cell type
 - 6.1.3 Settings for CAN bus pins
 - 6.1.4 Setting for terminal resistors
- 6.2 Configuring RESU Plus
 - 6.2.1 Setting for communication interface
 - 6.2.2 Settings for CAN bus pins
 - 6.2.3 Setting for terminal resistors

7 Commissioning

- 7.1 Status indicators
 - 7.1.1 Battery pack
 - 7.1.2 RESU Plus
- 7.2 Commissioning battery pack
- 7.3 Shutting down battery pack

8 Troubleshooting

9 Firmware Update

- 9.1 Updating battery pack firmware
- 9.2 Updating RESU Plus firmware

10 Warranty

11 Certifications

A Compatible Inverters

B Supported Memory Cards

1 Safety

NOTE

To use rechargeable batteries, installers are required to comply with standard AS/NZS 5139 in Australia, VDE-AR-E2510-2 in Germany, and the domestic legislation in other countries.

1.1 Symbols on product labels

The nameplate is attached to the left side of the battery pack, and the warning label is attached to the top.

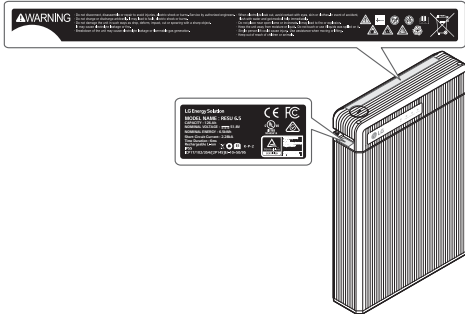

The voltage of this battery pack is strong enough to cause electric shock.



Make sure that the battery polarity is connected correctly.



Keep the battery pack away from open flame or ignition sources.



Keep the battery pack away from children.



Read the manual before installing and operating the battery pack.



The battery pack is heavy enough to cause severe injury.



The battery pack may leak corrosive electrolyte.



The battery pack may explode.



The battery pack should not be disposed of with household waste at the end of its working life.



The battery pack should be disposed of at a proper facility for environmentally safe recycling.

1.2 Safety instructions

For safety reasons, installers are responsible for familiarizing themselves with the contents of this manual and all warnings before performing installation.

1.2.1 General safety precautions

⚠ WARNING

Failure to observe the precautions described in this section can cause serious injury to persons or damage to property.

Observe the following precautions:

- Risks of explosion
 - Do not subject the battery pack to strong impacts.
 - Do not crush or puncture the battery pack.
 - Do not dispose of the battery pack in a fire.
- Risks of fire
 - Do not expose the battery pack to temperatures in excess of 60°C.
 - Do not place the battery pack near a heat source, such as a fireplace.
 - Do not expose the battery pack to direct sunlight.
 - Do not allow the battery connectors to touch conductive objects such as wires.

- Risks of electric shock
 - Do not disassemble the battery pack.
 - Do not touch the battery pack with wet hands.
 - Do not expose the battery pack to moisture or liquids.
 - Keep the battery pack away from children and animals.
- Risks of damage to the battery pack
 - Do not allow the battery pack to get in contact with liquids.
 - Do not subject the battery pack to high pressures.
 - Do not place any objects on top of the battery pack.

1.2.2 Battery handling guide

- Use the battery pack only as directed.
- Do not use the battery pack if it is defective, appears cracked, broken or otherwise damaged, or fails to operate.
- Do not attempt to open, disassemble, repair, tamper with, or modify the battery pack. The battery pack is not user serviceable.
- To protect the battery pack and its components from damage when transporting, handle with care.
- Do not impact, pull, drag or step on the battery pack. Do not subject it to any strong force.
- Do not insert foreign objects into any part of the battery pack.
- Do not use cleaning solvents to clean the battery pack.
- Do not install the battery in a closed place where the ventilation is not available.

1.3 Response to emergency situations

The RESU battery pack comprises multiple batteries that are designed to prevent hazards resulting from failures. However, LG Energy Solution cannot guarantee their absolute safety.

1.3.1 Leaking batteries

If the battery pack leaks electrolyte, avoid contact with the leaking liquid or gas. Electrolyte is corrosive and contact may cause skin irritation and chemical burns. If one is exposed to the leaked substance, do these actions:

Inhalation: Evacuate the contaminated area, and seek medical attention immediately.

Eye contact: Rinse eyes with flowing water for 15 minutes, and seek medical attention immediately.

Skin contact: Wash the affected area thoroughly with soap and water, and seek medical attention immediately.

Ingestion: Induce vomiting, and seek medical attention immediately.

1.3.2 Fire



In case of a fire, make sure that an ABC or carbon dioxide extinguisher is nearby.

⚠ WARNING

The battery pack may catch fire when heated above 150°C.

If a fire breaks out where the battery pack is installed, do these actions:

1. Extinguish the fire before the battery pack catches fire.
2. If the battery pack has caught fire, do not try to extinguish the fire. Evacuate people immediately.

⚠ WARNING

If the battery catches fire, it will produce noxious and poisonous gases. Do not approach.

1.3.3 Wet batteries

If the battery pack is wet or submerged in water, do not try to access it. Contact LG Energy Solution or your distributor for technical assistance.

1.3.4 Damaged batteries

Damaged batteries are dangerous and must be handled with extreme caution. They are not fit for use and may pose a danger to people or property. If the battery pack seems to be damaged, pack it in its original container, and then return it to LG Energy Solution or your distributor.

⚠ CAUTION

Damaged batteries may leak electrolyte or produce flammable gas. If you suspect such damage, immediately contact LG Energy Solution for advice and information.

1.4 Qualified installers

This manual and the tasks and procedures described herein are intended for use by skilled workers only. A skilled worker is defined as a trained and qualified electrician or installer who has all of the following skills and experience:

- Knowledge of the functional principles and operation of on-grid systems.
- Knowledge of the dangers and risks associated with installing and using electrical devices and acceptable mitigation methods.
- Knowledge of the installation of electrical devices
- Knowledge of and adherence to this manual and all safety precautions and best practices.

1.5 Contact information

Use the contacts below for technical assistance. These phone numbers are available only during business hours on weekdays.

	Telephone	Email
Europe	+49 6196 5719 660	techcenterue@lgensol.com
USA	+1 888 375 8044	CSNorthAmericaESS@lgensol.com
Australia	+61 1300 178 064	essserviceau@lgensol.com
Korea and other regions		essservice@lgensol.com

2 Product Introduction**2.1 Technical data****2.1.1 Dimensions and weight**

	RESU3.3	RESU6.5	RESU10	RESU Plus
Length	452 mm (17.80 in)	452 mm (17.80 in)	452 mm (17.80 in)	216 mm (8.50 in)
Width	120 mm (4.72 in)	120 mm (4.72 in)	227 mm (8.94 in)	120.5 mm (4.74 in)
Height	402.5 mm (15.85 in)	655.5 mm (25.81 in)	484 mm (19.06 in)	156 mm (6.14 in)
Weight ¹	31 kg (68.3 lb)	52 kg (114.6 lb)	75 kg (165.3 lb)	2 kg (4.4 lb)

¹A battery pack's weight varies slightly depending on its battery cells' weight.

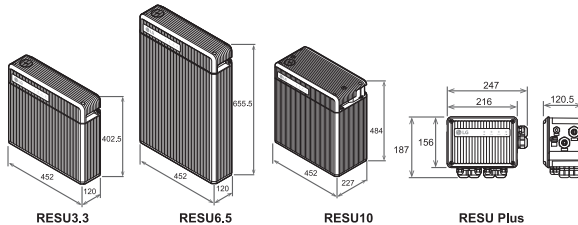
**2.1.2 Performance**

	RESU3.3	RESU6.5	RESU10
Nominal voltage	51.8 V	51.8 V	51.8 V
Operating voltage	42 to 58.8 V	42 to 58.8 V	42 to 58.8 V
Nominal capacity	63 A·h	126 A·h	189 A·h
Nominal energy ¹⁾	3.3 kW·h	6.5 kW·h	9.8 kW·h
Standard power	1.1 kW	2.2 kW	3.3 kW
Maximum power	3 kW	4.2 kW	5 kW
Peak power for 3 seconds	3.3 kW	4.6 kW	7 kW
Peak current for 3 seconds	78.6 A	109.5 A	166.7 A
Maximum current	71.4 A at 42 V	100 A at 42 V	119 A at 42 V
Charge current	18.9 A	37.8 A	56.7 A
Discharge current	18.9 A	37.8 A	56.7 A

1) Actual usable energy at the AC output may vary by condition, such as inverter efficiency and temperature

If two battery packs are used, the nominal capacity and energy are equal to the sums of the two, but the maximum and peak power are equal to those of RESU10.

Faradic charge efficiency (25°C/77°F)	99%
Battery round-trip efficiency (C/3, 25°C/77°F)	95%
Expected lifetime at 25°C/77°F	More than 10 years
Communication interface	CAN 2.0B
Cooling	Natural convection

2.1.3 Charging cable requirements

Conductor cross-sectional area	33 to 50 mm ²
Outer diameter	14 to 21 mm
Lug hole size	M8
Lug width	21 mm
Maximum cable length	5 m per cable

2.1.4 Network cable requirements

Category	Cat 5e
Connector	8P8C without any kind of boots

2.1.5 Environmental requirements

Available operating temperature	-10 to 50 °C (14 to 122 °F)
Optimal operating temperature	15 to 30 °C (59 to 86 °F)
Storage temperature	-30 to 60 °C (-22 to 140 °F)
Humidity	5 to 95% (non-condensing)
Altitude	Below 2000 m (6562 ft)

• Short Circuit Current / Duration

	RESU6.5	RESU 10	RESU plus
Short Circuit Current	2.28kA	2.853kA	2.72kA
Duration	6ms	5ms	15ms

• Arc Flash Protection Calculations

In order to protect personnel from the possibility of being injured by an arc flash hazard, Arc flash calculation of the battery system is estimated with the Incident Energy Calculations refer to Annex D of NFPA 70E.

	RESU6.5	RESU 10	RESU plus
Battery System Voltage	58.8V	58.8V	58.8V
Battery System Internal Resistance	0.0251Ω	0.0206Ω	0.0216Ω
Bolted Fault Current	2.28kA	2.853kA	2.72kA
Arcing Current	1.14kA	1.4265kA	1.36kA
Clearing Time	6ms	4ms	5ms
Arc Flash Incident Energy	0.0035 Cal/cm ²	0.0015 Cal/cm ²	0.0018 Cal/cm ²
Working Distance	450mm(18inch)	450mm(18inch)	450mm(18inch)

Battery system installers must wear PPE(Personal Protective Equipment) according to NFPA 70E Article 130, referring to the calculation results above.

⚠ WARNING

- When install the battery system, the worker shall wear arc-rated clothing in every occasions and places to protect him/her from any possible exposure to an electric arc flash.
- The arc-rated clothing that the worker is wearing must assure the worker's movement and visibility while covering all ignitable clothing.
- The worker shall wear the non-conductive safety helmet every occasions and places to protect him/her from any danger of head injury from electric shock or burns due to the contact with energized electrical conductors or circuit parts resulting from electrical explosion.
- The worker shall wear non-conductive protective equipment for the face, neck, and chin in every occasions and places to protect him/her from any danger of injury from exposure to electric arcs or flashes resulting from electrical explosion.
- The worker shall wear non-conductive protective equipment for the eyes in every occasions and places to protect him/her from any danger of injury from electric arcs, flashes resulting from electrical explosion.
- The worker shall wear hearing protection within the arc flash boundary.
- The worker shall wear Heavy-duty leather gloves or arc-rated gloves, satisfying the following regulation level, for arc flash protection. In the case of wearing the rubber gloves for the shock protection, he/she shall wear additional leather protectors above the gloves.
- The worker shall wear Heavy-duty leather footwear or dielectric footwear or both to provide some arc flash protection.
- The worker shall inspect Arc-rated apparel before every use.
- Work clothing or arc flash suits that are contaminated or damaged to the extent, impairing the protective qualities, shall not be used.
- Protective items that become contaminated with grease, oil, or flammable liquids or combustible materials shall not be used.
- The garment manufacturer's instructions for care and maintenance of arc-rated apparel shall be followed.
- Arc-rated apparel shall be stored in a manner that prevents physical damage; damage from moisture, dust, or other deteriorating agents or contamination from flammable or combustible materials.

2.2 Features

The RESU® battery pack has the following features:

Energy storage unit : This battery pack is designed for domestic photovoltaic system compatibility.

Battery management system (BMS) : The battery pack's built-in BMS monitors its operation and prevents the battery from operating outside design limitations. See 8. Troubleshooting.

Easy firmware update : The BMS firmware can be updated to the latest version. See 9. Firmware Update.

Expandability : The battery capacity can be increased by adding another battery pack. See 2.5 RESU Plus.

2.3 Maintenance

RESU 3.3/6.5/10 does not require maintenance during normal operation if properly installed per the installation manual. In the event of fault, contact the regional service center.

2.4 RESU lineup

There are three RESU battery pack models.

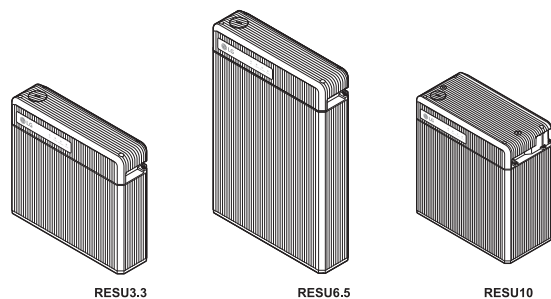

RESU3.3

RESU6.5

RESU10

For details about these models, See 2.1 Technical data.

2.5 RESU Plus

The RESU battery pack can be used in combination of up to 2 units.

- RESU3.3 + RESU3.3
- RESU3.3 + RESU6.5
- RESU3.3 + RESU10
- RESU6.5 + RESU6.5
- RESU6.5 + RESU10
- RESU6.5 + RESU12
- RESU10 + RESU10
- RESU10 + RESU12
- RESU12 + RESU12
- RESU13 + RESU13

(only RESU13s can be used in combination)

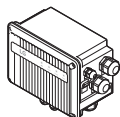

A unit of RESU Plus, which is sold separately, is required to install two RESU battery packs. Two battery packs are connected to an inverter via a RESU Plus.

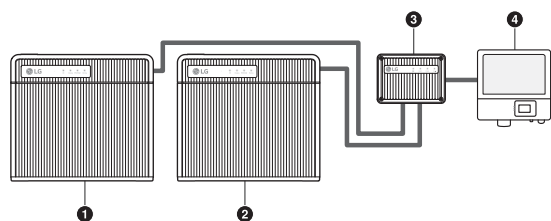

1) 1st battery pack
3) RESU Plus

2) 2nd battery pack
4) Inverter

Use this procedure to install two battery packs using the RESU Plus.

1. Secure the RESU Plus to the wall.
2. Secure two battery packs to the wall.
3. Connect power and network cables to the RESU Plus.
4. Connect the power and network cables to the inverter.
5. Connect the power and network cables to the battery packs.

3 Installation Prerequisites

3.1 Installation materials

These installation materials shall be prepared by installers.

- Charging cable
- Network cable
- Ground wire
- RJ45 plug
- Silicone sealant or putty

NOTICE

Make sure that the cross-sectional area of charging cables is 33 to 50 mm².

3.2 Installation location

Make sure that the installation location meets the following conditions:

- The building is designed to withstand earthquakes.
- The location is far away from the sea, to avoid salt water and humidity.
- The floor is flat and level.
- There are no flammable or explosive materials nearby.
- The optimal ambient temperature is between 15 and 30°C.
- The temperature and humidity stays at a constant level.
- There is minimal dust and dirt in the area.
- There are no corrosive gases present, including ammonia and acid vapor.

NOTICE

The RESU battery pack is rated at IP55 and thus can be installed outdoors as well as indoors. However, if installed outdoors, do not allow the battery pack to be exposed to direct sunlight and moisture.

NOTICE

If the ambient temperature is outside the operating range, the battery pack stops operating to protect itself. The optimal temperature range for the battery pack to operate is 15°C to 30°C. Frequent exposure to harsh temperatures may deteriorate the performance and lifetime of the battery pack.

3.3 Tools

These tools are required to install the battery pack.



Torque screwdriver



Phillips-screwdriver bit

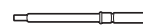

Hex-key bit



Phillips-head screwdriver



Flat-head screwdriver



Torque wrench

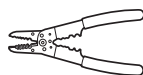

Wire stripper

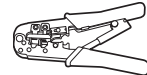

Cable crimper



Voltmeter

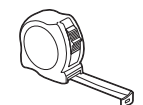

Tape measure



Drill



Sealant gun

Use properly insulated tools to prevent accidental electric shock or short circuits. Use adjustable tools and measuring instruments that are certified for precision and accuracy.

3.4 Safety gear

Wear the following safety gear when dealing with the battery pack. Installers must meet the relevant requirements of international standards, such as IEC 60364 or the domestic legislation.



Insulated gloves



Safety goggles



Safety shoes

3.5 Making network cable

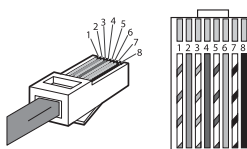

Use this method to make a network cable, which is to be connected between the battery pack and the inverter or the RESU Plus

- Cut network cable to the needed length.
- Strip 2.5 to 5 cm of the outer sheath at one end of the cable.
- Untwist and separate each pair of wires.
- Arrange the wires in this order:
 - White with an orange stripe
 - Orange
 - White with a green stripe
 - Blue
 - White with a blue stripe
 - Green
 - White with a brown stripe
 - Brown
- Bring the sorted wires together, and trim them to about 1.4 cm in length.
- Hold the RJ45 plug with the copper contacts facing up, and insert the wires into the plug, making sure that they stay aligned and each color goes into its appropriate channel.
- Put the plug into a cable crimper and squeeze the handles thoroughly.
- If available, use a LAN cable tester to see if the cable is faulty.

Repeat these steps for the other end of the cable.

4 Battery Pack Installation

⚠ WARNING

The battery pack is too heavy for one to carry. Make sure that two or more persons are available.

4.1 Unpacking

Unpack the battery pack from its packaging.

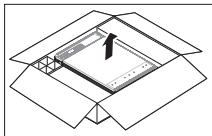

- Cut the packing tape and open the carton.
- Remove the drill template.

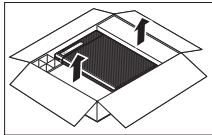

- Remove the honeycomb cushioning pads.

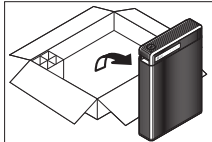

- Pull out the battery pack and stand it upright. Check if the battery pack is damaged.

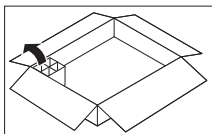

- All the other items are contained in a box in one corner of the carton. Take them out and check if any item is missing. See 4.2 Package items.

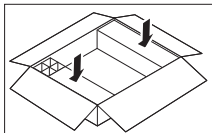

- Replace the honeycomb cushioning pads. Keep the carton for future storage or transportation.

4.2 Package items

These items are included in the package.



Battery pack



Screw anchors



Cable grommets



Screws



Mounting brackets

The table below lists the number of each item included.

Large grommets for charging cables	2
Small grommets for other cables	3
Mounting brackets	2
M6 × 40 screw anchors	6 (2 as spare)
M5 × 8 screws	4

Use only the parts included with the battery pack, except for the screw anchors, to ensure proper installation. If anything is damaged or missing, contact LG Energy Solution or your distributor.

4.3 Optional accessories

These baseplates and shelves are sold separately.

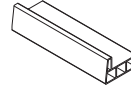

Baseplate for RESU3.3 and RESU6.5

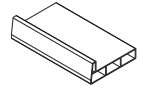

Baseplate for RESU10

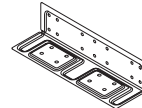

Shelf for RESU3.3 and RESU6.5



Shelves for RESU10

Use these accessories in a place where the floor may get wet occasionally.

4.4 Checks before installation

There are a few things to check before installing the battery pack to ensure that it has no defects.

⚠ WARNING

If this checking task is required for any reason after the battery packs is fully installed, make sure that the inverter is turned off while checking the battery pack.

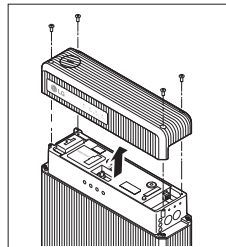

- Remove the top cover. Loosen the four hex-socket screws at each corner of the cover, and pull it up.
- Make sure to set the **SW select** DIP switch to 0011₂. See 6.1 Configuring Battery pack.

NOTE

possible to measure the voltage of the battery pack only if the **SW select** DIP switch is set to 0011₂.

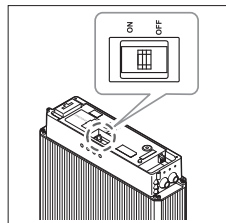

- At the first installation, make sure that the circuit breaker switch is in the Trip position between the **ON** and **OFF** positions.
- Push the circuit breaker switch behind the **OFF** position until it cannot go any further and then push it to the **ON** position. If the switch moves by itself to any of the other positions, do not use the battery pack. Contact LG Energy Solution or your distributor.

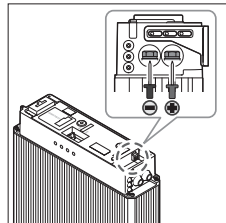

- Measure the voltage at the terminal block using a voltmeter. If the voltage is lower than 38 V, do not use the battery pack. Contact LG Energy Solution or your distributor.

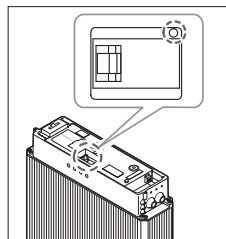

- Press the circuit breaker's trip button. If the circuit breaker switch has not moved to the Trip position, do not use the battery pack. Contact LG Energy Solution or your distributor.

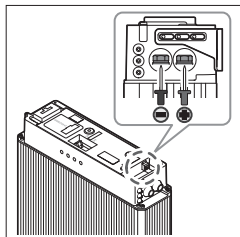

7. Measure the voltage at the terminal block using a voltmeter. If the voltage is higher than 0 V, do not use the battery pack. Contact LG Energy Solution or your distributor.

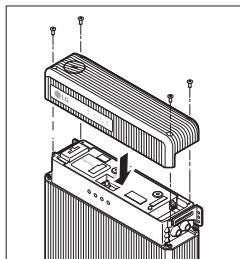

8. To secure the battery pack to the wall, replace the top cover and tighten the screws to a torque of 2.75 N-m.

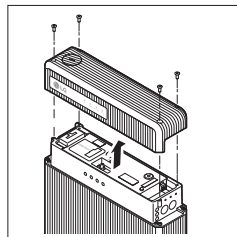

5. Remove the top cover.

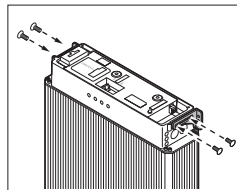

6. There are screw holes for mounting brackets on the top of the both sides of the battery pack. Drive the M5 screws through the mounting brackets into the holes and tighten them to a torque of 5 N-m.

4.5 Installation clearance

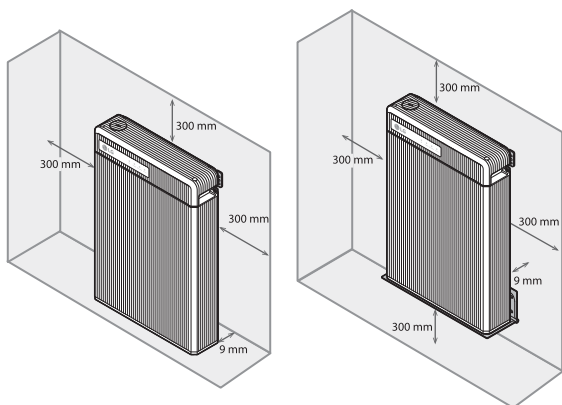

Make sure to leave a space of at least 9 mm between the battery pack and the wall. A clearance of at least 9 mm must be left around the battery pack for proper cooling.

NOTICE

Make sure that the battery pack is always exposed to the ambient air. The battery pack is cooled by natural convection. If the battery pack is entirely or partially covered or shielded, it may cause the battery pack to stop operating.

4.6 Securing battery pack to wall

Secure the battery pack to a wall to prevent it from moving. If the battery pack is installed above the floor or on a platform, make sure that the wall or platform is capable of supporting the battery pack's weight.

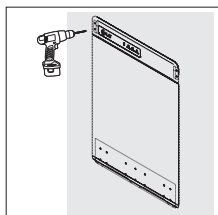

1. Determine where the mounting brackets are to be placed using the drill template.
2. Drill holes in the wall for the M6 (0.25 in) screw anchors. The drilling depth should be at least 50 mm.

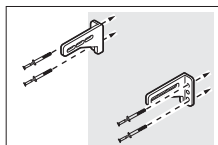

3. Drive the screw anchors through the mounting brackets into the holes.
4. Tighten the screws to a torque of 5 N-m.

NOTE

It is allowed to use any other type of fastening suitable for the wall material.

4.7 Cable connections

⚠ WARNING

Make sure that the inverter is turned off before connecting the battery pack to the inverter.

4.7.1 Connecting ground wire

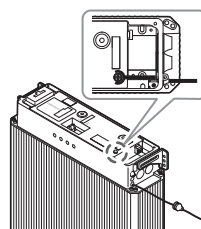

Grounding between the battery pack and the inverter is not mandatory but recommended.

1. Feed the ground wire from the inverter or RESU Plus through a small grommet and then through the bottom of the small cable entries.
2. Connect the ground wire to the ground screw, and tighten it to a torque of 4 N-m. The screw type is M5.
3. Push the grommet into the cable entry.

4.7.2 Connecting network cable

It is required for the battery pack to communicate with the inverter for proper operation. Connect a network cable between the battery pack and the inverter or RESU Plus.

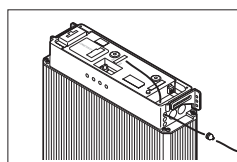

1. The small grommet is too small for an RJ45 plug to pass through. Without RJ45 plug at the end, feed the network cable through a small grommet and then through the top of the small cable entries.

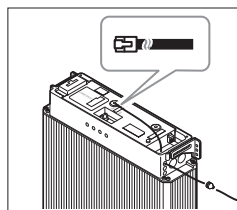

2. Attach an RJ45 plug to the network cable using a wire stripper and cable crimper. See 3.5 Making network cable.

NOTE



Do not attach any boot to the network cable to keep the connector short. Using a connector longer than 23 mm may prevent the top cover from being reassembled properly.

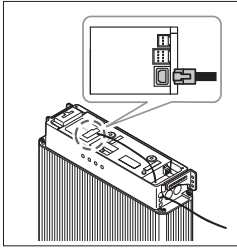

3. Connect the network cable to the network port.
4. Push the grommet into the cable entry.

4.7.3 Connecting power cables for RESU Plus

NOTE

Skip this task if the RESU Plus is not installed.

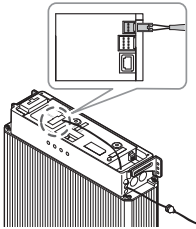

To supply power to the RESU Plus for its operation, connect the provided power cables from the battery pack to the RESU Plus.

1. Insert the connector of the power cable into the power connector.
2. Feed the power cable through the middle of the small cable entries and then through a small grommet
3. Push the grommet into the cable entry.

4.7.4 Connecting charging cables

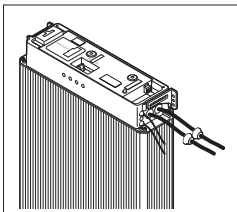

1. Feed a pair of charging cables through each of the large grommets and then through each of the large cable entries.

NOTICE

Pay attention not to reverse polarity. Connection with reversed polarity causes severe damage to the battery pack.

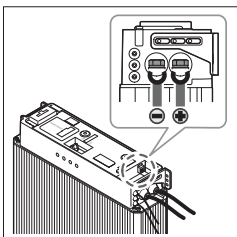

2. Connect the charging cables to the terminal block.
 - a) Remove the terminal cover plate, which is placed over the terminal block to protect it.
 - b) Connect the negative cable (-) to the terminal on the left and the positive cable (+) to the one on the right. Tighten the hex-socket screws to a torque of 6 N·m.
 - c) Place the cover back on top.
3. Push the grommets into the cable entries.

4.8 Finalizing installation

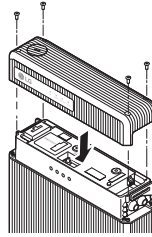

Follow these steps to finalize the installation.

1. Stuff the small grommets left unused with an insulating material like silicone sealant, and then push them into the remaining holes.
2. Apply silicone sealant or putty around the cable at each grommet to prevent foreign materials from entering the battery pack.
3. Check if the configuration switches are set properly, referring to 6.1 Configuring Battery pack.
4. Turn on the battery pack as described in 7.2 Commissioning battery pack.
5. Replace the top cover and tighten the screws to a torque of 5 N·m.

5 RESU Plus Installation

NOTE

Skip this chapter if only one battery pack is to be installed.

5.1 Unpacking

Unpack the RESU Plus from its packaging.

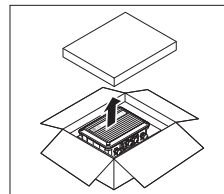

1. Cut the packing tape and open the carton.
2. Remove the cover of the inner box.

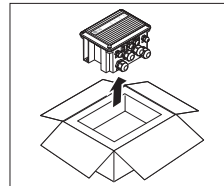

3. Pull out the RESU Plus.
4. Check if the RESU Plus is damaged.
5. Keep the carton for future storage or transportation.

5.2 Package items

These items are included in the package.



RESU Plus



Anchor bolts

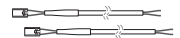

Power cable

The RESU Plus has glands and grommets attached to their own places.

The table below lists the number of each item included.

Power cables	2
Anchor bolts	2

5.3 Securing RESU Plus to wall

Secure the RESU Plus to a wall to prevent it from moving.

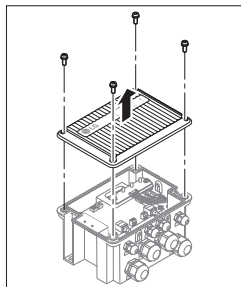

1. Remove the front cover of the RESU Plus. Loosen the screws at each corner of the cover and pull it up.

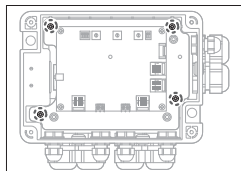

2. Loosen the screws at each corner of the metal plate that supports the circuit board. Be careful not to separate the circuit board from the metal plate.

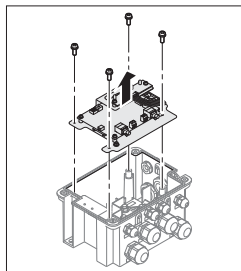

3. Pull up the circuit board to remove it.

NOTICE

To prevent the circuit board from being damaged or soiled, keep it in a safe place until it is replaced.

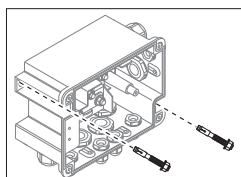

4. Determine where the anchor bolts are to be placed.
5. Drill holes in the wall for the M8 (0.3 in) anchor bolts. The drilling depth should be 50 mm at least.
6. Drive the anchor bolts into the wall holes through the screw holes at the upper left and the lower right of the rear of the RESU Plus.
7. Tighten the anchor bolts to a torque of 8 N·m.

5.4 Cable connections

⚠ WARNING

Before connecting cables to the RESU Plus, make sure that the inverter and battery packs are turned off.

5.4.1 Connecting charging cables

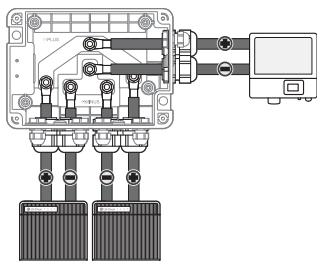

1. Loosen the sealing nuts of the large glands.
2. Feed charging cables through the large glands, and connect each charging cable to its corresponding terminal. Use the terminal block at the lower left for the first battery pack, the one at the lower right for the second battery pack, and the one at the upper for the inverter.

3. Tighten the sealing nuts firmly.
4. Check if the configuration switches on the circuit board are set properly, referring to 6.2 Configuring RESU Plus.

NOTICE

Pay attention not to reverse polarity. Connection with reversed polarity causes severe damage to the battery pack.

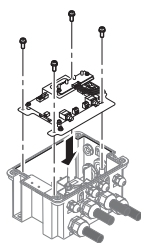

To connect other kinds of cables, replace the circuit board and tighten the screws to a torque of 1 N·m. On the circuit board, there are network ports, ground points, and terminals to supply power to the RESU Plus for its operation.

5.4.2 Connecting ground wires

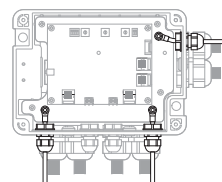

Grounding between the battery pack and the inverter is not mandatory but recommended.

1. Loosen the sealing nuts of the small glands that are closest to the edges.
2. Feed ground wires through the glands.
3. Connect each ground wire to its corresponding ground point. Use the ground point at the lower left for the first battery pack, the one at the lower right for the second battery pack, and the one at the upper for the inverter.
4. Tighten the sealing nuts firmly.

5.4.3 Connecting power cables

To supply power to the RESU Plus for its operation, connect the provided power cables from the battery packs to the RESU Plus.

NOTE

Power cables must connect from both battery packs to ensure that the RESU Plus operates normally even when either battery pack is off.

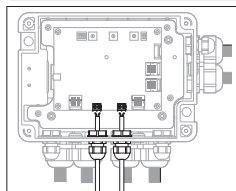

1. Loosen the sealing nuts of the small glands in the middle.
2. Feed power cables through the glands.

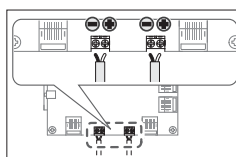

3. Connect each power cable to its corresponding terminal block. Use the terminal block at the left for the first battery pack and the one at the right for the second battery pack. Connect the negative line (-) to the terminal on the left and the positive line (+) to the one on the right.
4. Tighten the sealing nuts firmly.

5.4.4 Connecting network cables

It is required for the battery packs to communicate with the inverter via the RESU Plus for their proper operation.

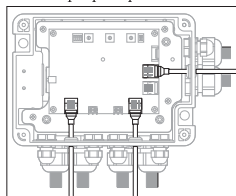

1. Connect each network cable to its corresponding network port. Use the port at the lower left for the first battery pack, the one at the lower right for the second battery pack, and the one at the upper for the inverter.

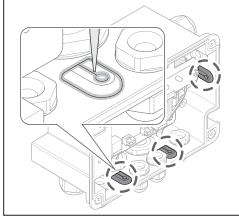

2. Apply silicone sealant or putty around the grommets and their slit.

5.5 Finalizing installation

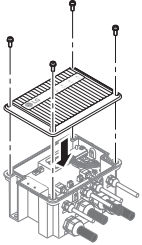

Follow these steps to finalize the installation.

1. Check if the configuration switches on the RESU Plus and both battery packs are set properly, referring to 6.2 Configuring RESU Plus and 6.1 Configuring Battery pack.
2. Turn on the battery pack as described in 7.2 Commissioning battery pack.
3. Replace the front cover and tighten the screws to a torque of 1 N·m.

6 Configuration Switches

The RESU battery pack and RESU Plus have inside DIP switches and rotary switches, which must be set correctly for proper communication with the inverter.

6.1 Configuring Battery pack

Remove the switch cover by pulling it up to expose the circuit board.

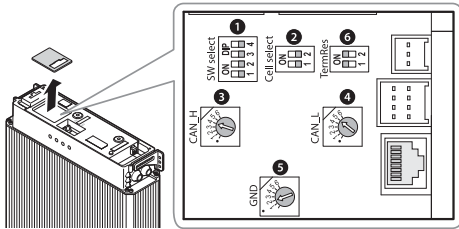

Switch number	Type	Label	Default
1	DIP	SW select	0000 ₂
2	DIP	Cell select	00 ₂
3	Rotary	CAN_H	4
4	Rotary	CAN_L	5
5	Rotary	GND	2
6	DIP	Term Res	11 ₂

6.1.1 Setting for communication interface



Only one battery pack is installed, set the **SW select** DIP switch to 0011₂. Otherwise, if two are installed, set it to 0010₂. This switch is initially set to 0000₂.

NOTE

To be more precise, when a RESU battery pack is directly connected to an inverter, the **SW select** DIP switch must be set to 0011₂. When two battery packs are installed, they must be connected to a RESU Plus. In the case, they are indirectly connected to the inverter via the RESU Plus, and thus the switch must be set to 0010₂.

Configuration Switches

The number of battery packs	Value	Setting
1	0011 ₂	
2	0010 ₂	

6.1.2 Setting for battery cell type



Make sure that the **Cell select** DIP switch is set to 00₂.

6.1.3 Settings for CAN bus pins



Make sure that the **CAN_H** rotary switch is set to 4. This switch indicates which pin is used for CAN high signal by the inverter.



Make sure that the **CAN_L** rotary switch is set to 5. This switch indicates which pin is used for CAN low signal by the inverter.



Make sure that the **GND** rotary switch is set to 2. This switch indicates which pin is used for ground by the inverter.

Only 1st to 5th pins can be used.

CAN_H	CAN_L	GND	Setting
4	5	2	

6.1.4 Setting for terminal resistors



Make sure that the **TermRes** DIP switch is set to 11₂.

Bit	On	Off
1	CAN terminal resistor attached	CAN terminal resistor unattached
2	Unused	Unused

6.2 Configuring RESU Plus

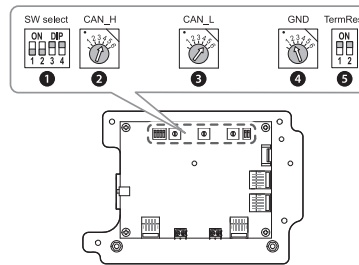

Switch number	Type	Label	Default
1	DIP	SW select	0011 ₂
2	Rotary	CAN_H	4
3	Rotary	CAN_L	5
4	Rotary	GND	2
5	DIP	Term Res	11 ₂

6.2.1 Setting for communication interface



Make sure that the **SW select** DIP switch is set to 0011₂.

6.2.2 Settings for CAN bus pins

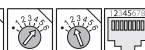

See the section of the same title 6.1.3 Settings for CAN bus pins.

6.2.3 Setting for terminal resistors



Make sure that the **TermRes** DIP switch is set to 11₂. See the section of the same title 6.1.4 Settings for terminal resistors.

7 Commissioning

7.1 Status indicators

7.1.1 Battery pack

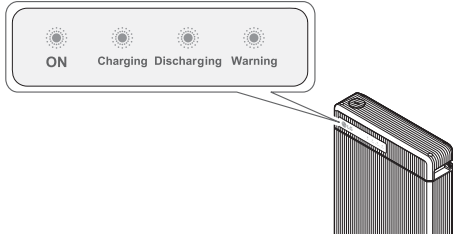

There are four LED indicators on the front of the battery packs to show its operating status.

ON: This indicator stays on while the battery pack is supplied with power for operation.

Charging: This stays on while the battery pack is charging.

Discharging: This stays on while the battery pack is discharging.

Warning: This comes on when the battery pack is in a warning state. See 8. Troubleshooting.

7.1.2 RESU Plus

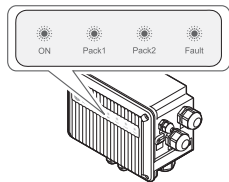

There are four LED indicators on the front of the RESU Plus to show its operating status.

ON: This indicator stays on while the battery pack is supplied with power for operation.

Pack 1: This stays on while the first battery pack is online with the RESU Plus.

Pack 2: This stays on while the second battery pack is online with the RESU Plus.

Fault: This comes on when one or both battery packs are in a warning or fault state. See 8. Troubleshooting.

NOTE

At the first commissioning, or when one is additionally installed later, one of the two battery packs may be inoperative due to the voltage difference between them. The responsible battery pack cannot be online with the RESU Plus until its voltage level becomes the same as that of the normal one.

7.2 Commissioning battery pack

If only one battery pack is installed, follow these steps to put it in operation.

1. Move the circuit breaker switch to the **ON** position to turn on the battery pack.
2. Make sure that the **ON** indicator is on. If it stays off, do not use the battery pack. Contact LG Energy Solution or your distributor.
3. Turn on the inverter.

If two battery packs are installed, follow these steps to put them in operation.

1. Move the circuit breaker switch to the **ON** position to turn on the battery packs. If two battery packs are installed, both must be turned on at an interval of less than 30 seconds.
2. On both battery packs, make sure that the **ON** indicator is on. If it stays off, do not use the battery pack. Contact LG Energy Solution or your distributor.
3. On the RESU Plus, make sure that either or both of the **Pack 1** and **Pack 2** indicators are on. The **Fault** indicator of the RESU Plus may come on temporarily until both battery packs are initialized.
4. Turn on the inverter.

NOTE

If communication with the inverter is not established within 10 minutes after the battery pack is turned on, the circuit breaker automatically trips.

7.3 Shutting down battery pack

To shut down the battery pack, follow these steps:

1. Turn off the inverter.
2. Remove the top cover from the battery pack.
3. Turn off the battery pack by moving the circuit breaker switch to the **OFF** position.
4. Make sure that every indicator on the battery pack is off.
5. Replace the top cover.

8 Troubleshooting

Check the indicators on the front to determine the state of the battery pack. A warning state is triggered when a condition, such as with voltage or temperature, is beyond design limitations. The battery pack's BMS periodically reports its operating state to the inverter.

When the battery pack falls outside prescribed limits, it enters a warning state. When a warning is reported, the inverter immediately stops operation.

Use the monitoring software on the inverter to identify what caused the warning. The possible warning messages are as follows:

- Battery Over Voltage
- Battery Under Voltage
- Battery Over Temperature
- Battery Under Temperature
- Battery Discharge Over Current
- Battery Charge Over Current
- BMS Internal Communication
- Battery Cell Voltage Imbalance

The abnormal state is cleared when the battery pack recovers normal operation.

NOTE

For a serious warning, if no proper corrective actions are taken by the inverter, the battery pack's circuit breaker automatically trips to protect itself.

9 Firmware Update

It is possible to update the BMS firmware. Use a memory card to update it. A new firmware may be available from LG Energy Solution website or your distributor.

Prepare a memory card with these properties.

- The capacity of the memory card must not be greater than 32 GB.
- The memory card must be formatted in FAT16 or FAT32.
- It must have only one firmware file in the root directory.

For details about supported memory cards, see B. Supported Memory Cards.

9.1 Updating battery pack firmware

Follow these steps to update the firmware of the battery pack.

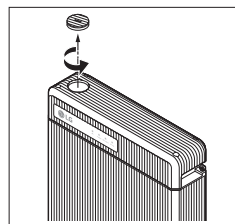

1. Turn off the inverter.
2. There is a round lid on the left part of the top cover, covering the memory card slot below it. Turn the lid counterclockwise and pull it up to remove it.

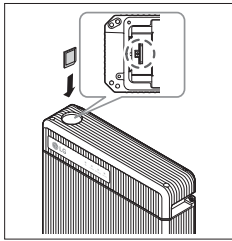

3. Insert the memory card into the memory card slot.

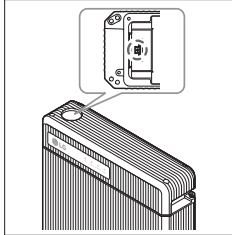

4. Press and hold the update button beside the memory card slot for more than 3 seconds.

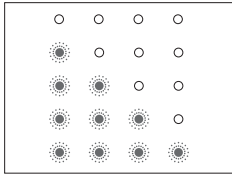

5. The LED indicators flash in cycles for 1 minute at most until the firmware update is complete. Only the **ON** indicator comes on when the firmware update is successful. If it fails, the **Warning** indicator comes on for two seconds. Check the memory card and try again. If it persistently fails, contact LG Energy Solution or your distributor.

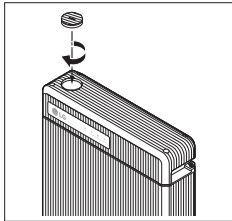

6. Remove the memory card. Push the memory card gently until it is disengaged from the slot, and pull it out.

7. Replace the lid.

8. Turn on the inverter.

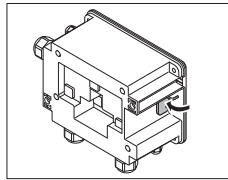

6. Remove the memory card. Push the memory card gently until it is disengaged from the slot, and pull it out.

7. Close the flap.
8. Turn on the inverter.

9.2 Updating RESU Plus firmware

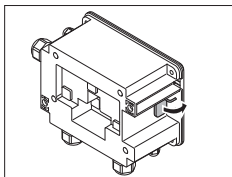

1. Turn off the inverter.
2. Open the flap on the left side of the RESU Plus.

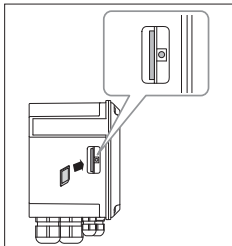

3. Insert the memory card into the memory card slot.

4. Press and hold the update button beside the memory card slot for more than 3 seconds.

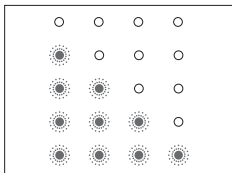

5. The LED indicators flash in cycles for 1 minute at most until the firmware update is complete. Only the **ON** indicator comes on when the firmware update is successful. If it fails, the **Fault** indicator comes on for two seconds. Check the memory card and try again. If it persistently fails, contact LG Energy Solution or your distributor.

10 Warranty

LG Energy Solution protects this product under warranty when it is installed and used as detailed in this manual. Violating the installation procedure or using the product in any way not described in this manual immediately voids all warranties on the product.

LG Energy Solution does not provide warranty coverage or assume any liability for direct or indirect damages or defects that result from the following causes:

- Improper transportation or storage
- Incorrect installation, wiring or handling
- Non-compliance with LG Energy Solution's installation manual
- Operating the product in an inappropriate environment
- Incorrect or inappropriate operation
- Insufficient ventilation
- Failure to adhere to safety warnings or instructions
- Repairs or modifications performed by unauthorized personnel
- Inverter failure or overcurrent.
- Force majeure events
- External influences, such as unusual physical or electrical stress.
- Use of an incompatible inverter

11 Certifications

Battery pack safety	CE, FCC, RCM, TUV (IEC 62619), UL 1973
Battery cell safety	UL 1642
UN number	UN 3480
Hazardous materials classification	Class 9
UN transportation testing requirements	UN 38.3
International protection marking	IP55

A Compatible Inverters

For information about inverters that are compatible with the RESU battery pack, visit LG Energy Solution's website.

- Australia: <https://www.lgessbattery.com/au/home-battery/product-info.lg>
- USA: <https://www.lgessbattery.com/us/home-battery/product-info.lg>
- Spain: <https://www.lgessbattery.com/es/home-battery/product-info.lg>
- Germany: <https://www.lgessbattery.com/de/home-battery/product-info.lg>
- Italy: <https://www.lgessbattery.com/it/home-battery/product-info.lg>
- Europe: <https://www.lgessbattery.com/eu/home-battery/product-info.lg>

B Supported Memory Cards

Most memory cards can be used for firmware update. However, some memory cards may not be supported, depending on manufacturers and models. These memory cards are tested and guaranteed to work by LG Energy Solution.

- SanDisk SDHC 4 GB
- SanDisk Ultra SDHC10 8 GB
- SanDisk Ultra MicroSD1 8 GB
- Transcend SDHC4 32 GB
- Transcend SDHC10 600x 32 GB
- Transcend Premium 400x MicroSD10 8 GB
- Transcend Premium 400x MicroSD10 16 GB
- Transcend Premium 400x MicroSD10 32 GB
- Toshiba Exceria MicroSD3 32 GB



Keep this manual for later use.

© 2021 LG Energy Solution ESS Battery Division
PARC1, 108, Yeoui-daero, Yeongdeungpo-gu, Seoul, Republic of Korea, 07335
<https://www.lghomebattery.com> <http://www.lgensol.com>